

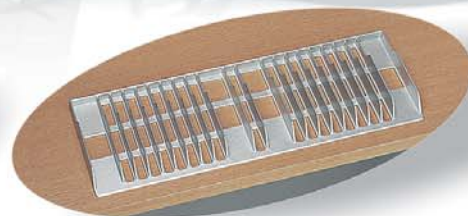

2.9 Cassettenhalter



Cassettenhalter

cassette holder

Art.-Nr. Verp. Einheit Ausfuhrung Farben: Standard
 art.-no. packing units type colours: standard

60.4590

1.400

CD Cassettenhalter
 fur 17 Einfach- und 4 Doppel-CD's
 320 x 110 x 20 mm
CD cassette holder
 for 17 single and 4 double CD's
 320 x 110 x 20 mm

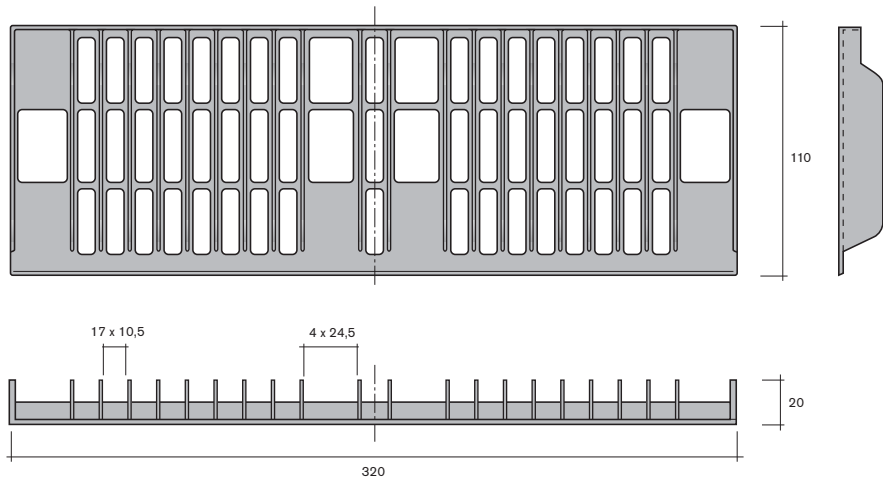
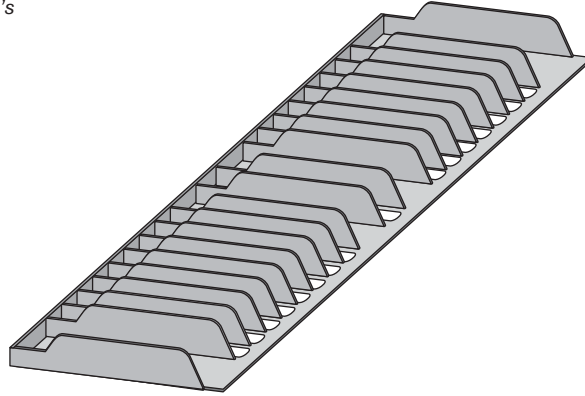

60.4430

2.400

CD Cassettenhalter
 fur 8 Einfach- und 2 Doppel-CD's
 220 x 145 x 12 mm
CD cassette holder
 for 8 single and 2 double CD's
 220 x 145 x 12 mm

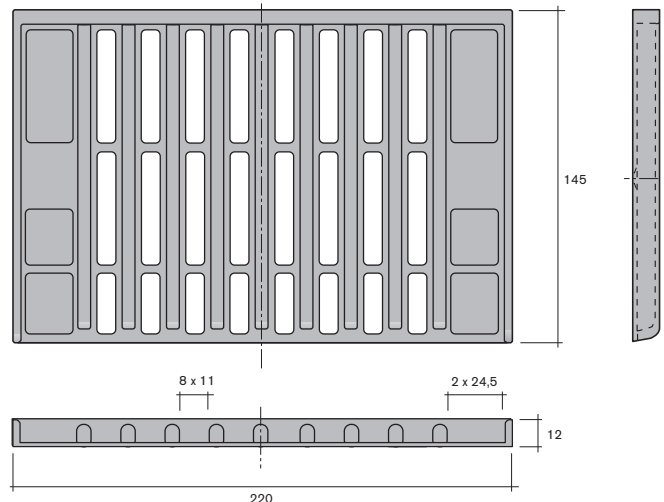

Cassettenhalter

cassette holder

Art.-Nr. Verp. Einheit Ausfuhrung Farben: Standard
art.-no. *packing units* *type* *colours: standard*

60.4740

6.050

CD Cassettenhalter
fur 8 Einfach- und 2 Doppel-CD's
220 x 70 x 10 mm
CD cassette holder
for 8 single and 2 double CD's
220 x 70 x 10 mm

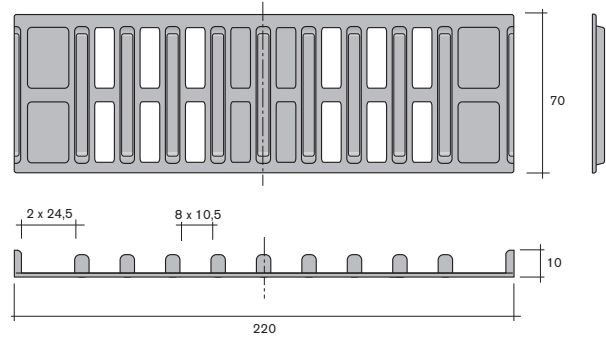

60.4770

6.050

CD Cassettenhalter
fur 15 Einfach- und 1 Doppel-CD
222 x 70 x 10 mm
CD cassette holder
for 15 single and 1 double CD
222 x 70 x 10 mm

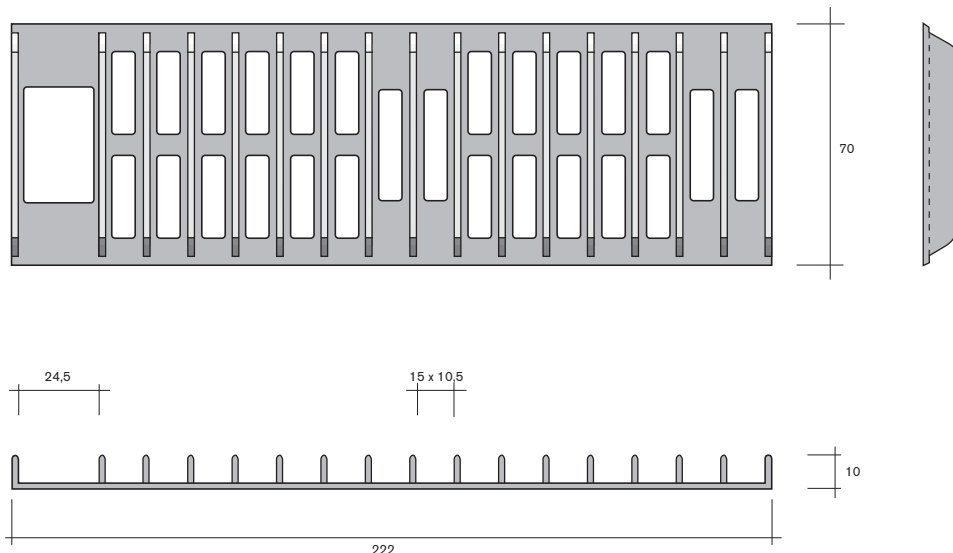
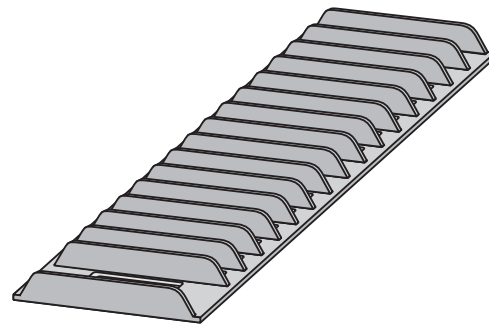

Cassettenhalter

cassette holder

Art.-Nr. Verp. Einheit Ausfuhrung Farben: Standard
 art.-no. packing units type colours: standard

60.4130

450

CD Cassettenhalter
 fur 20 Einfach-CD's
 280 x 26 x 20 mm
CD cassette holder
 for 20 single CD's
 280 x 26 x 20 mm

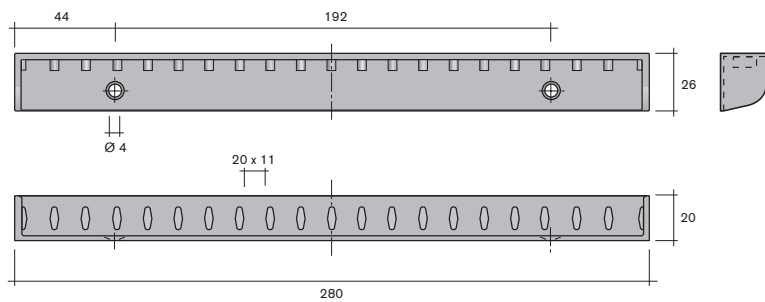

60.4480

3.500

MC Cassettenhalter
 fur 13 MC's
 320 x 70 x 10 mm
MC cassette holder
 for 13 MC's
 320 x 70 x 10 mm

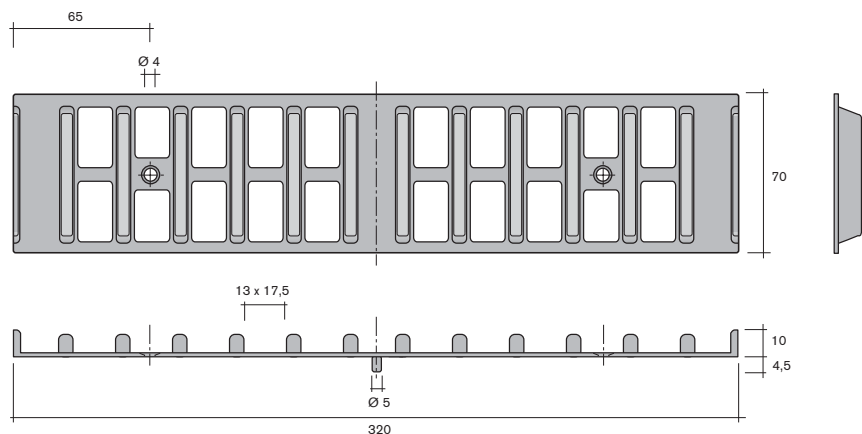

Cassettenhalter

cassette holder

Art.-Nr. Verp. Einheit Ausfuhrung Farben: Standard
 art.-no. packing units type colours: standard

60.4110

450

MC Cassettenhalter
 fur 13 MC's
 280 x 26 x 20 mm
MC cassette holder
 for 13 MC's
 280 x 26 x 20 mm

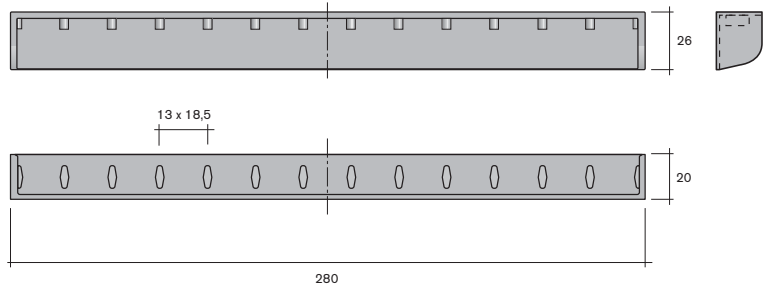

60.4580

2.750

VC Cassettenhalter
 fur 9 VC's 320 x 110 x 10 mm
VC cassette holder
 for 9 VC's 320 x 110 x 10 mm

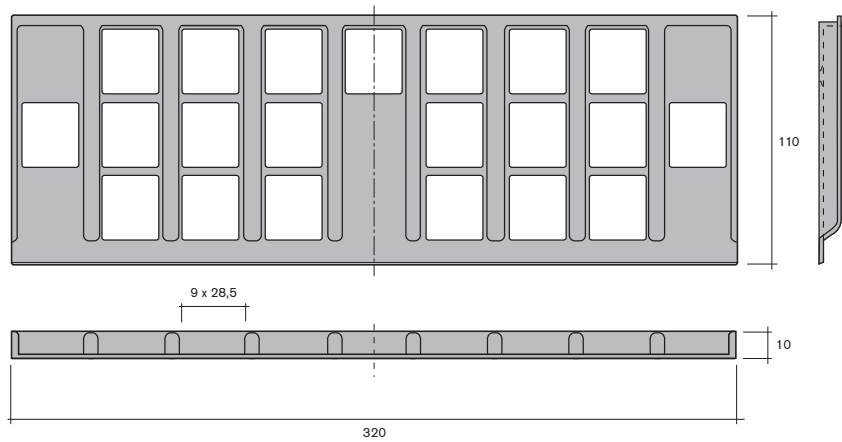

60.4120

450

VC Cassettenhalter
 fur 9 VC's
 280 x 26 x 20 mm
VC cassette holder
 for 9 VC's
 280 x 26 x 20 mm

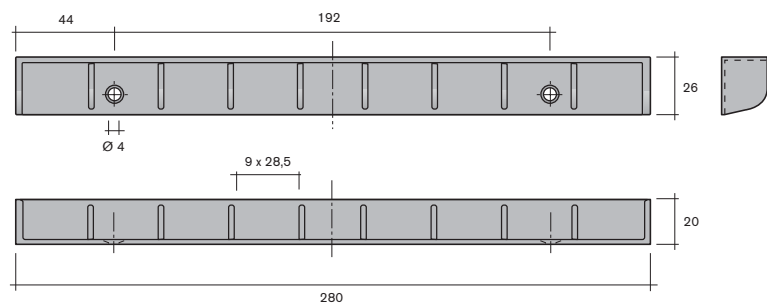

Cassettenhalter

cassette holder

Art.-Nr.
art.-no.

Verp. Einheit
packing units

Ausfuhrung
type

Farben: Standard
colours: standard

60.4880

250

Drehbeschlag

belastbar bis 30 kg, zweiteilig montiert
Befestigungsbohrungen $\varnothing 4 \times 160$ mm Tlg.

turntable

loadable to 30 kg, mounted in two parts
holes $\varnothing 4 \times 160$ mm spacing

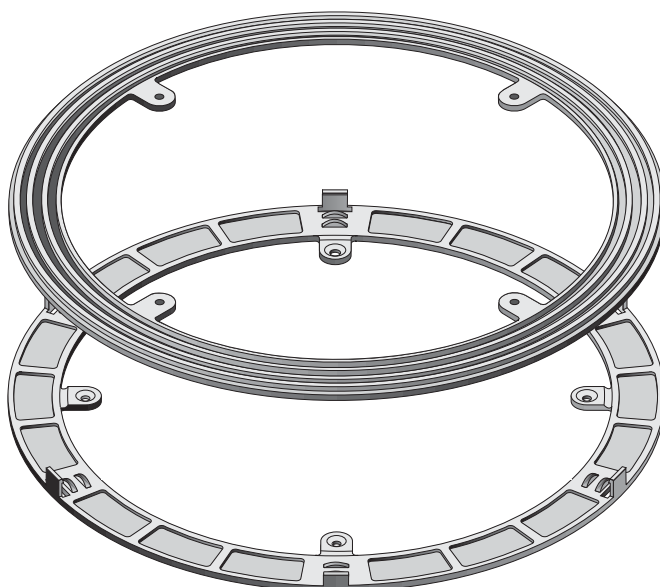
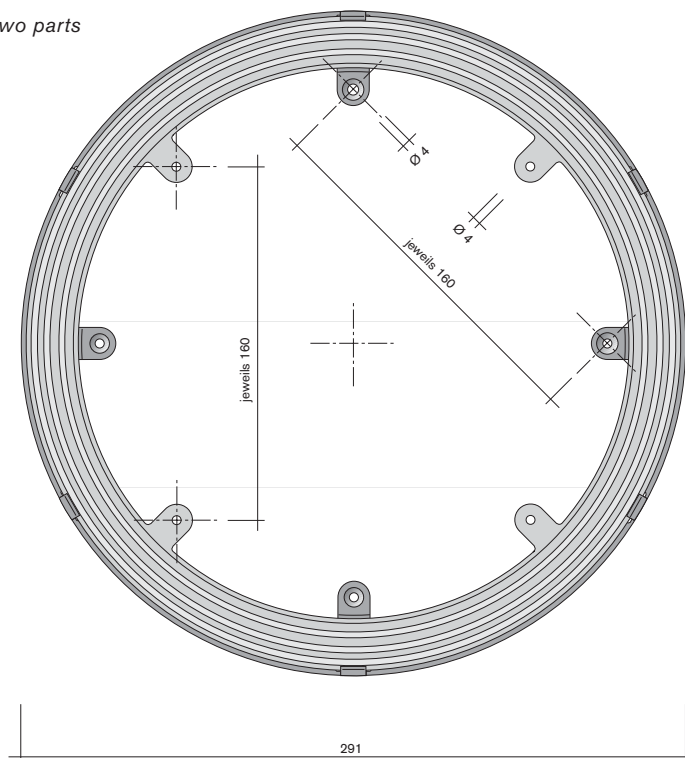

Cassettenhalter

cassette holder

Art.-Nr. <i>art.-no.</i>	Verp. Einheit <i>packing units</i>	Ausfuhrung <i>type</i>	Farben: Standard <i>colours: standard</i>
-----------------------------	---------------------------------------	----------------------------	--

