



2.5 Laufleisten

Mittelführungen



Laufleisten

drawer slides

Ausfuhrung
type

Beschreibung
description

1

Laufleiste zum Eindubeln

Bohr raster 32 mm
In einigen Modellen befinden
sich zusatzliche Schraublocher
drawer slide for dowelling
dowel spacing 32 mm
Some types have additional
screw holes

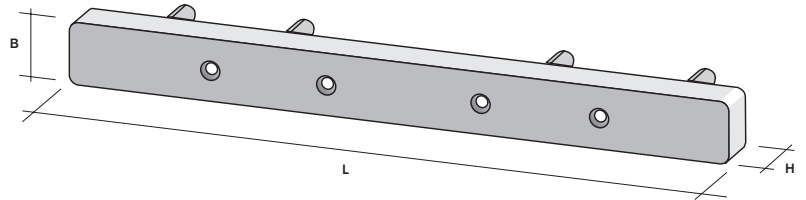

2

Laufleiste zum Anschleen

mit markierten Einschubfeldern
drawer slide for stapling
with marked stapling areas

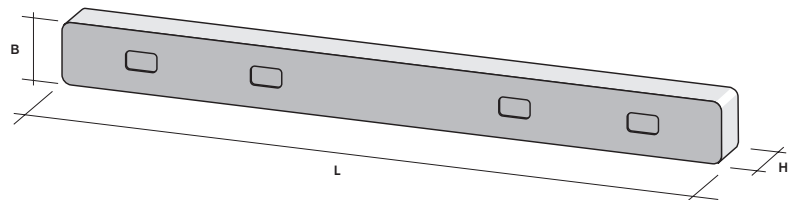

3

Laufleiste zum Anschrauben

Schraublocher 32 mm Bohrraster
drawer slide screwable
spacing 32 mm

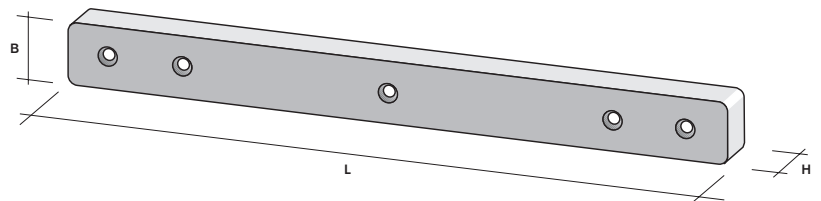

4

Laufleiste zum Eindubeln

Bohr raster 32 mm
In einigen Modellen zusatzlich
Schraubloch/locher.
drawer slide for dowelling
dowel spacing 32 mm
Some types have additional
screw hole(s).

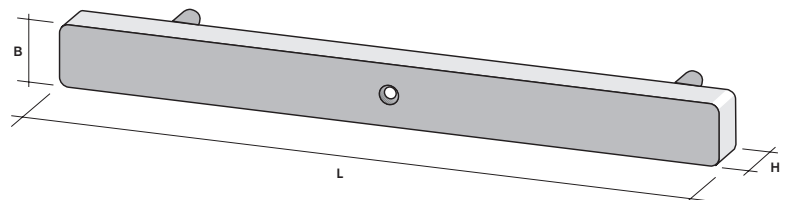

5

Laufleiste

Dubel- oder Lochreihe
drawer slide
dowels or screw holes

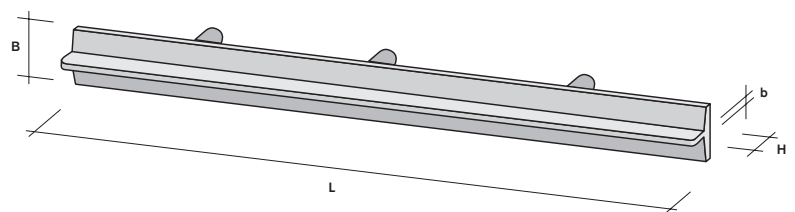

Laufleisten

drawer slides

Ausfuhrung
type

Beschreibung
description

6

**Laufleiste zum Dubeln,
Schrauben oder Anschleen**
mit Stopstift, rechte und linke
Ausfuhrung
**drawer slide with dowels,
screw on or stapling**
with stop, type right and left

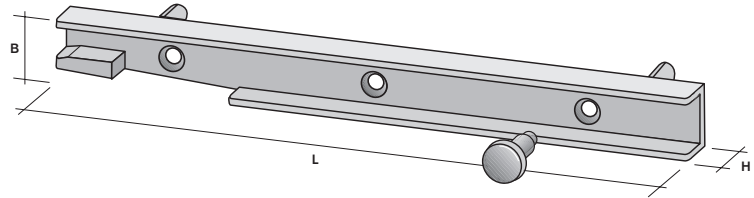

7

**Laufleiste zum Dubeln
und Schrauben**
**drawer slide with dowels
and screw on**

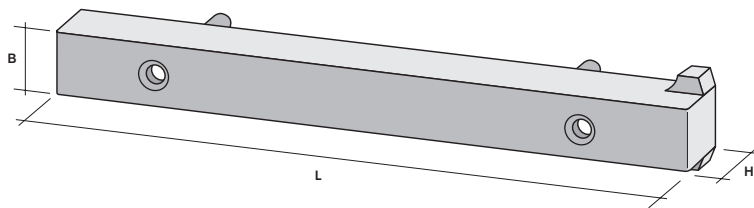

8

**Laufleiste zum Dubeln,
Schrauben oder Anschleen**
mit Stopkante
**drawer slide with dowels,
screw on or stapling**
with stopping edge

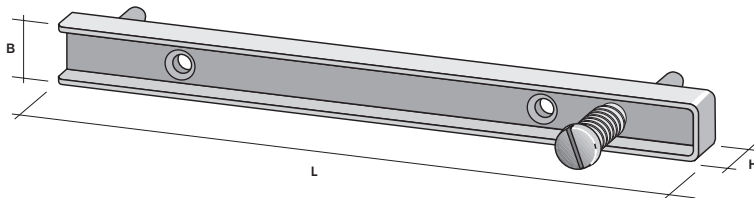

Laufleisten

drawer slides

Art.-Nr. art.-no.	Verp.-Einh. packing unit	Ausführ. type	Breite B width B	Höhe H height H	Länge L length L	Dübel dowel	Dübelabstand von vorn dowel-spacing from the front	schraubbar screwable	Lochabstand von vorn hole spacing from the front	schießbar for stapling	m. Stoppkante w. stop. edge
31.0840	1.000	5	24/9	32,5	331	2 x ø 5	14/288/29	-	-	-	-
31.1200	200	5	24/9	39	331	2 x ø 5	14/288/29	-	-	●	-
31.1880	900	1	10	10	130	2 x ø 8	17/96/17	-	-	-	-
31.0880	1.500	4	10	11	228	3 x ø 5	18/96/96/18	-	-	-	-
31.1590	450	4	10	17,2	299	2 x ø 5	14/256/29	-	-	-	-
31.1000	2.400	8	11,8	8,2	229	-	-	●	14,5/80/112/22,5	●	●
31.1010	1.100	8	12	16,2	230	-	-	●	15/80/112/23	●	●
31.0130	650	1	15	11	287	4 x ø 8	31,5/64/96/64/31,5	●	31,5/64/96/64/31,5	-	-
31.0850	500	4	15	14,5	329	2 x ø 5	28/287/14	●	8,5/64/92,5/164	-	-
31.0100	800	1	15,5	8	287	4 x ø 8	31/64/96/64/32	●	6/25/64/96/64/32	-	-
31.2150	1.250	6	15,5	9,5	204	2 x ø 4,5	28,5/160/15,5	●	7,5/94,5/64/38	●	●
31.0970	1.400	1	16	8	186	3 x ø 5	29/64/64/29	●	13/160/13	-	-
31.1560	1.400	6	16	8	205	2 x ø 5	31/128/46	●	61/128/16	-	●
31.1600	1.000	4	16	8	260	2 x ø 5	31/223/6	●	130/130	-	-
31.0630	950	4	16	8	298	2 x ø 5	37/224/37	●	19/130/130/19	-	●
31.2260	950	4	16	8	298	2 x ø 5	26/256/16	●	16/133/149	-	●
31.2090	1.250	6	16	8	300	-	-	●	20/64/96/96/24	●	●
31.0790	950	4	16	8	260	3 x ø 5	6/96/128/30	-	-	-	-
31.2040	1.150	6	16	9,2	300	-	-	●	20/64/96/96/24	●	●
31.2130	1.150	6	16	9,2	300	-	-	-	-	●	●
31.2480	800	6	16	9,2	299	3 x ø 5	20/64/192/24	●	36/64/160/40	●	●
31.0780	1.500	6	16	10	200	-	-	●	27/78/78/17	●	●
31.0760	1.400	8	16	10	220	-	-	●	14/18/14/64/82/28	●	●
31.1210	1.400	8	16	10	220	-	-	-	-	●	●
31.1180	900	1	16	10	222	3 x ø 8	15/96/96/15	●	31/160/31	-	●
31.1840	900	8	16	10	222	4 x ø 8	15/32/64/96/15	●	31/160/31	-	●
31.1740	850	8	16	10	280	2 x ø 5	28/224/28	●	12/128/128/12	●	●
31.2000	1.200	8	16	10	280	-	-	●	12/128/128/12	●	●
31.1930	800	8	16	10	282	2 x ø 5	30/224/28	●	14/128/128/12	●	●
31.2100	1.100	6	16	10	300	-	-	●	20/64/96/96/24	●	●
31.0300	1.200	8	16	11	250	-	-	-	-	●	●
31.2310	750	8	16	11	400	-	-	-	-	●	●
31.2240	900	8	16	12	220	2 x ø 5	27,5/160/32,5	●	15/95/110	●	●
31.1280	1.200	8	16	12	220	-	-	●	-	-	-
31.2060	1.000	3	16	12	240	-	-	●	15/13/83/77/32	●	●
31.0310	1.000	2	16	12	250	-	-	-	24/96/96/24	-	-
31.2030	800	8	16	12	350	-	-	-	-	-	-
31.2200	650	8	16	13	274	5 x ø 8	8/32/32/96/96/10	-	20/32/64/64/40	-	-
31.1780	650	8	16	14	280	2 x ø 5	28/224/28	●	12/112/112/12	-	●
31.0610	450	7	16	15,5	268	3 x ø 5	30/128/96/14	-	-	-	●
31.1090	450	7	16	15,5	268	3 x ø 5	30/128/96/14	●	-	-	●
31.2210	800	8	16	16	205	2 x ø 5	29/160/16	●	38/64/64/39	-	-
31.1170	700	8	16	16	222	3 x ø 8	15/96/96/15	●	38,5/64/64/38,5	●	●
31.1700	500	8	16	16	299	2 x ø 5	29/256/14	●	39/64/64/132	-	●
31.1910	500	3	16	17	340	-	-	●	26/128/160/26	-	-
31.3010	500	3	16	17	340	-	-	●	D5=26/160/128/26, D3,7=37/192/111	-	-
31.2050	600	6	16	18	220	2 x ø 8	42/160/18	-	-	●	●
31.1850	650	8	16	18	222	4 x ø 8	15/32/64/96/15	●	12/32/66/82/28	●	●
31.0330	600	3	16	19	250	-	-	●	13/112/112/13	●	-
31.2320	500	8	16	20	222	3 x ø 8	15/96/96/15	●	31/160/31	-	●
31.2110	500	8	16	22	222	3 x ø 8	15/96/96/15	●	31/160/31	-	●
31.1800	450	8	26	16,8	285	-	-	●	30,5/53/146,5/55	-	●

Laufleisten drawer slides

Beschreibung
description

mit Rollen
with rollers

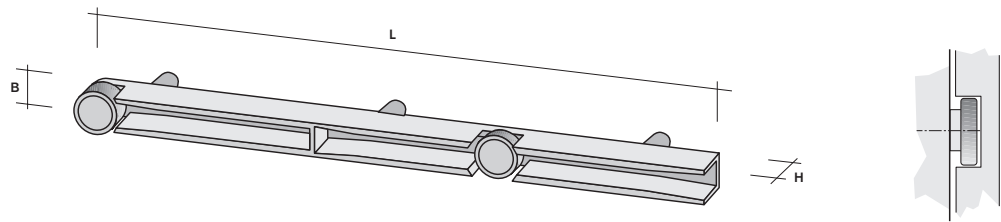

Art.-Nr. art.-no.	Verp.-Einh. packing unit	Ausfuhr. type	Breite B width B	Hohe H height H	Lange L length L	Dubel dowel	Dubelabstand von vorn dowel-spacing from the front	schraubbar screwable	Lochabstand von vorn hole spacing from the front	schiebar for stapling	m. Stoppkante w. stop. edge
31.1120	400	1	13	10	238	3 x \varnothing 6	10/96/96/36	●	48/44/74/58,5/13,5	●	●
31.2070	350	2	16	12	350,5	–	–	●	33,5/96/96/96/29	●	●
31.2890	250	2	16	12	350,5	4 x \varnothing 8	21/96/96/96/41	●	33,5/96/96/96/29	●	●

fur Drahtkorbe
for wire baskets

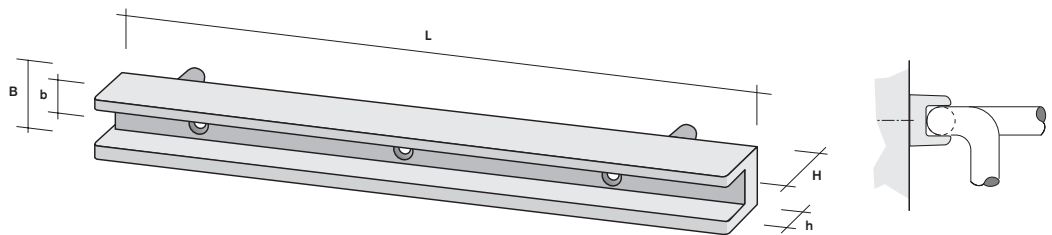

Art.-Nr. art.-no.	Verp.-Einh. packing unit	Breite B width B	Hohe H height H	Lange L length L	Breite innen b width ins. b	Hohe innen h height ins. h	Dubel dowel	Dubelabstand von vorn dowel-spacing from the front	schraubbar screwable	Lochabstand von vorn hole spacing from the front
31.2580	400	13	23	400	7	11	–	–	3 Euro	22/160/192/26
31.1650	300	14,5/32	12,5	511,5	7,8	6	2 x \varnothing 5	28/480/3,5	3	60/208/208/35,5
31.1651	300	14,5/32	12,5	511,5	7,8	6	–	–	3	60/208/208/35,5
31.0920	350	13	23	435	6,5	11	–	–	3 Euro	26/192/192/25
31.2290	190	27,5	27	495	5	10	–	–	15	25/14 x 32/22
31.1640	80	13,6/32	48	511,5	7,5	15	2 x \varnothing 5	28/480/3,5	3	60/208/208/35,5
31.2730	80	13,6/32	48	511,5	7,5	15	1 x \varnothing 5	28/483,5	3	60/208/208/35,5



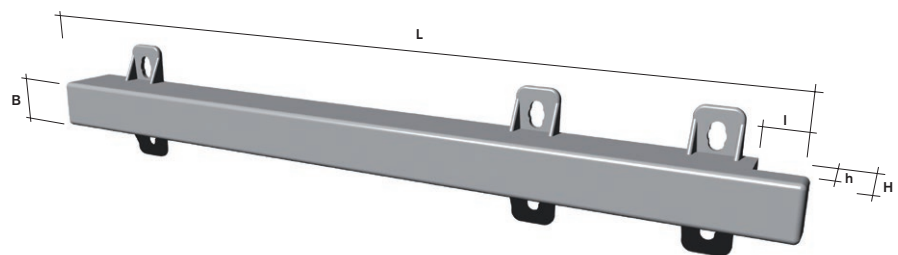







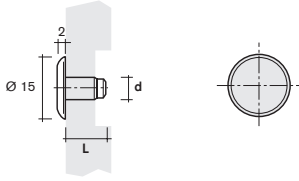

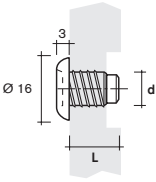
mit Aussparung und Anschraublaschen
with cut-out and bolting surface

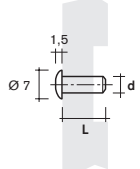

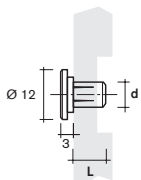
Art.-Nr. art.-no.	Verp.-Einh. packing unit	Breite B width B	Hohe H height H	Lange L length L	Hohe h height h	Lange l length l	schraubbar screwable	Lochabstand L-Richtung hole spacing L-direction	Lochabstand B-Richtung hole spacing B-direction	schiebar for stapling	m. Stoppkante w. stop. edge
31.3020	400	20	25	315	15	17	●	28/192/64/31	32	●	–

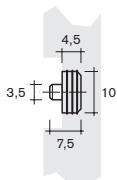
Stoppstifte für Laufleisten

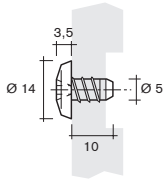
stops for drawer slides

Art.-Nr. art.-no.	Verp. Einheit packing units	Ausführung type	Farben: Standard colours: standard		
gesteckt plugged					
		$\varnothing d$	L		
49.0020	5.000	5,2 mm	8 mm		
49.0010	5.000	5,2 mm	10 mm		
49.0030	5.000	5,2 mm	12 mm		
eindrehbar, mit Schlitz screwable, with slot					
49.0500	3.000	8 mm	10 mm		
49.0520	3.000	8 mm	11,5 mm		
49.0510	3.000	8 mm	12 mm		
49.0530	3.000	8 mm	13,5 mm		
gesteckt plugged					
49.0070	5.000	4 mm	10,5 mm		
49.0490	5.000	4 mm	12 mm		
gesteckt plugged					
49.0080	5.000	6 mm	9,5 mm		
49.0040	5.000	6 mm	12,8 mm		
gesteckt plugged					
49.0060	4.000	10 mm	4,5 mm		
eindrehbar, mit Kreuzschlitz screwable, with slot					
49.0480	5.000	5 mm	10 mm		

Mittelführungen

centre drawer slides

Art.-Nr. Verp. Einheit Ausführung Farben: weiß, braun
 art.-no. packing units type colours: white, brown

31.3030

500

Winkelaufleiste schraubbar
 Teilung 288 mm
angle drawer slide, screwable
 spacing 288 mm

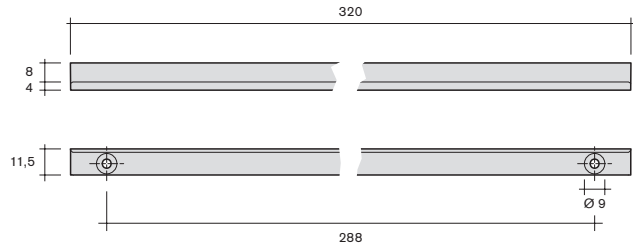
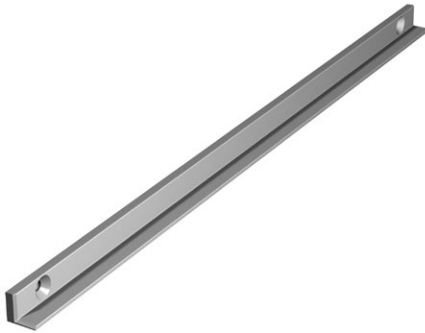

31.1520

500

schraubbar
 Teilung 96 mm
screwable
 spacing 96 mm

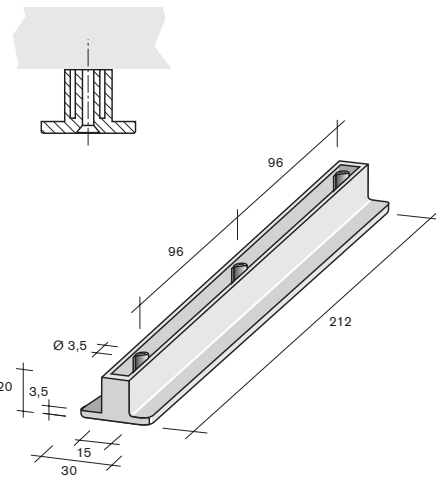

31.1020

85

4-fach gedübelt
 260 x 62 x 48 mm
 Dübel ø 6 mm
 Teilung 32/160/32
4-times dowelled
 260 x 62 x 48 mm
 dowel ø 6 mm
 spacing 32/160/32

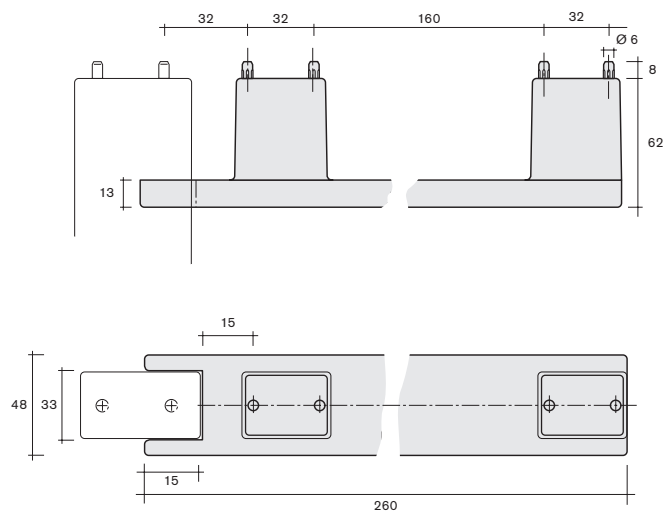

Mittelführungen

centre drawer slides

Art.-Nr. Verp. Einheit Ausfuhrung Farben: Standard
 art.-no. packing units type colours: standard

31.1950

75

3-fach gedubelt
 310 x 49 x 51,7 mm
 Dubel \varnothing 8 mm
 Teilung 224/32 mm
3-times dowelled
 310 x 49 x 51.7 mm
 dowel \varnothing 8 mm
 spacing 224/32 mm

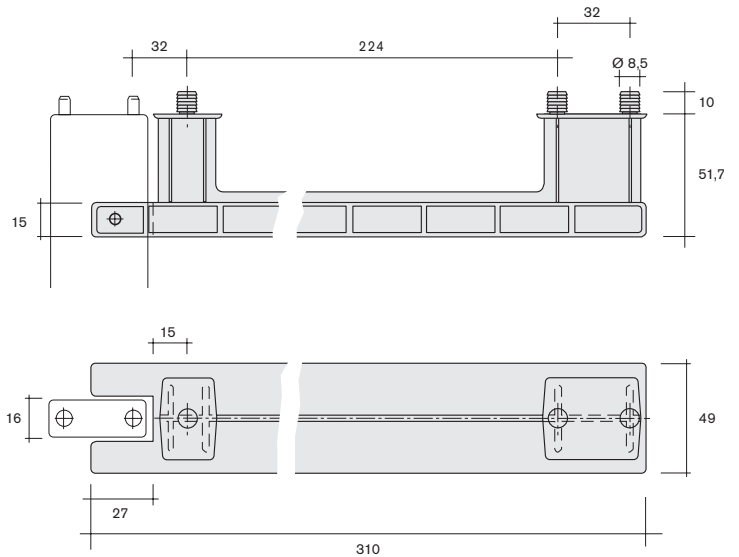

31.2570

600

**zur Anbringung zwischen
 Pfosten und Traverse**
*for fixing between
 shaft and crosspiece*

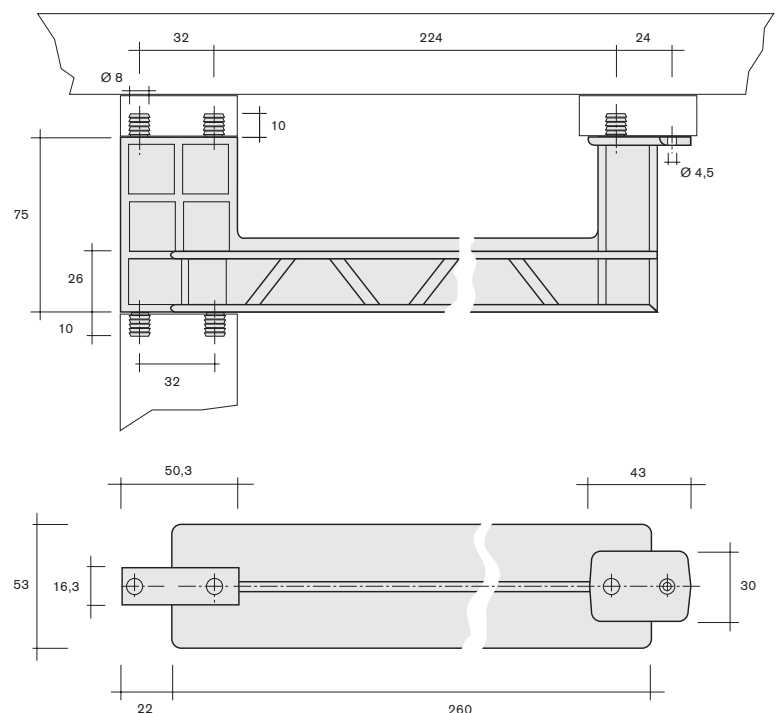

Mittelführungen

centre drawer slides

Art.-Nr. Verp. Einheit Ausführung Farben: weiß, braun
 art.-no. packing units type colours: white, brown

31.2600

400 **Mittelführung für BLUM-Führung**
 centre drawer slide for BLUM guide

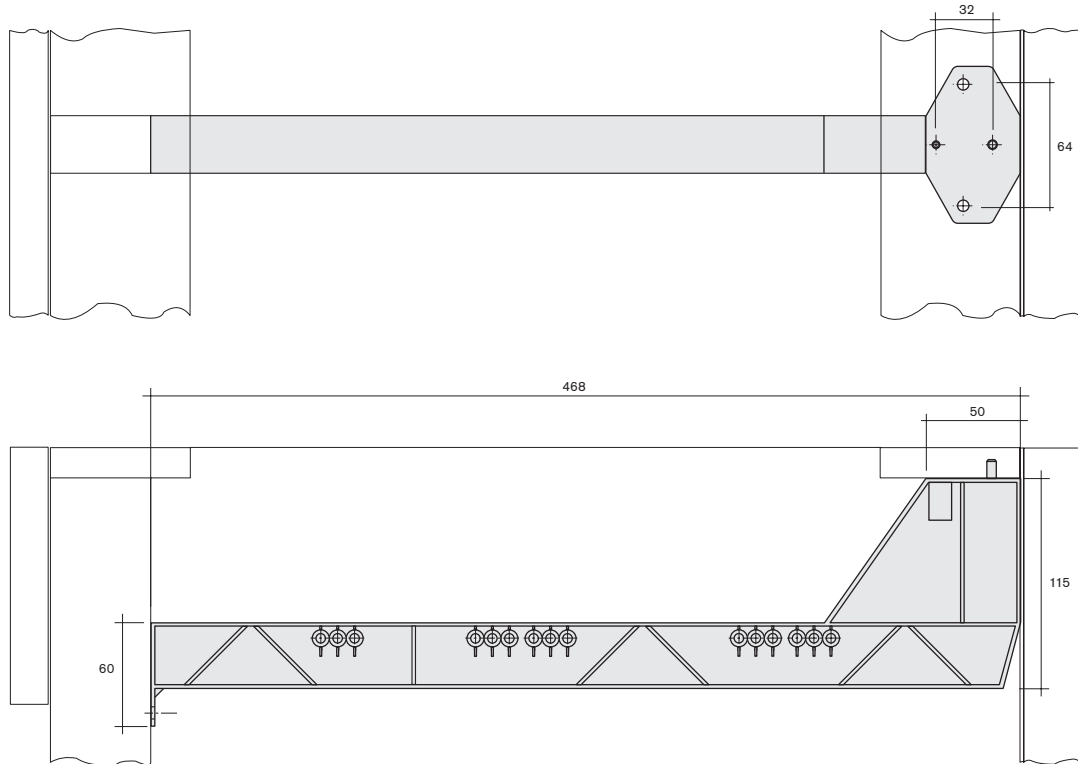

31.2950

400 **Mittelführung für Kugelauszüge**
 centre drawer slide for ball excerpts

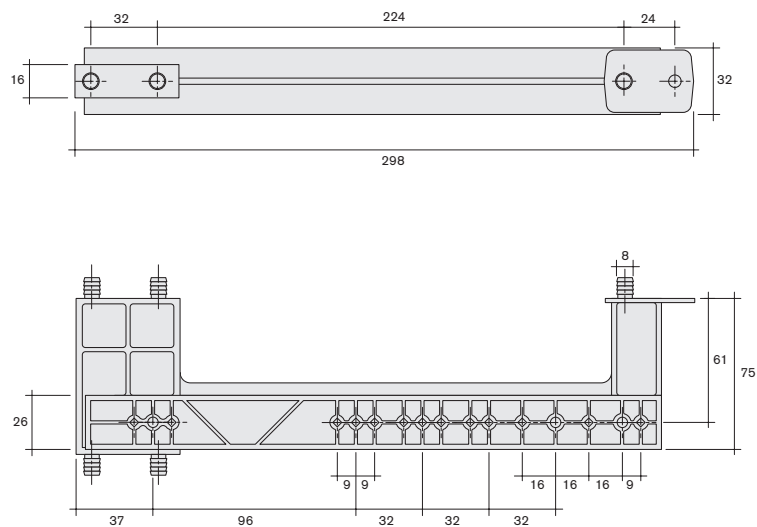

Mittelführungen

centre drawer slides

Art.-Nr. Verp. Einheit Ausfuhrung Farben: Standard
art.-no. packing units type colours: standard

31.3050

1000

Mittelfuhrung fur Schubkasten-Schienen-Aufnahme
centre slide for drawer rail admission

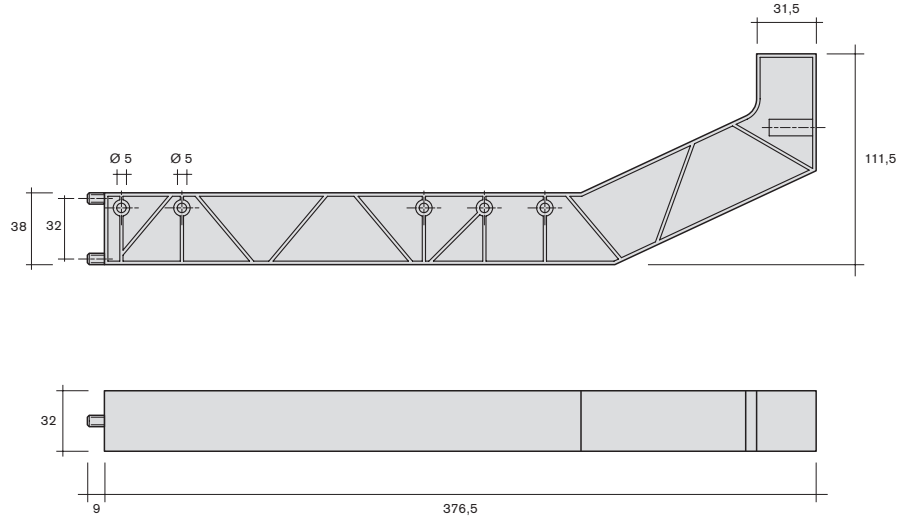

31.3040

900

Mittelfuhrung fur Schubkasten-Schienen-Aufnahme
centre slide for drawer rail admission

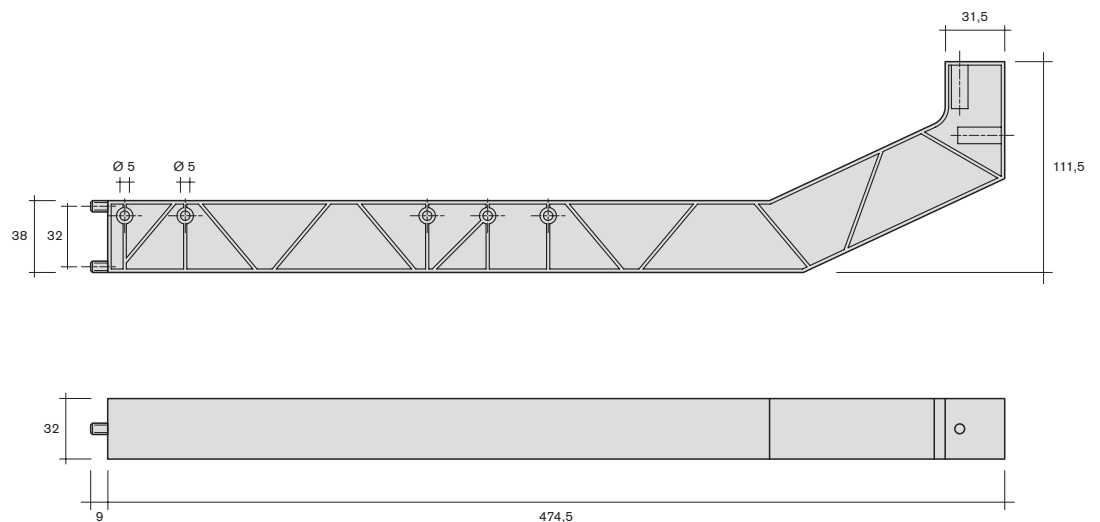

Mittelführungen

centre drawer slides

Art.-Nr. Verp. Einheit Ausfuhrung Farben: Standard
art.-no. packing units type colours: standard

31.2540

150

2-fach geschraubt

234 x 34,2 x 55 mm
Distanzma 55 fur 17 mm Nut
2 Locher fur Euro-Schraube
2-times screwed on
234 x 34.2 x 55 mm
distance measure 55 for 17 mm nut
2 holes for euro screw

